

**KORMANN**

**BAUSTOFFE**

**Kompetenz  
AM BAU**

[www.kormann.at](http://www.kormann.at)



**Tiefbau und Naturstein Sortiment**

**Im Grazer Süden**

Puntigamer Straße 140, 8055 Graz

SCHACHT Ringprogramm

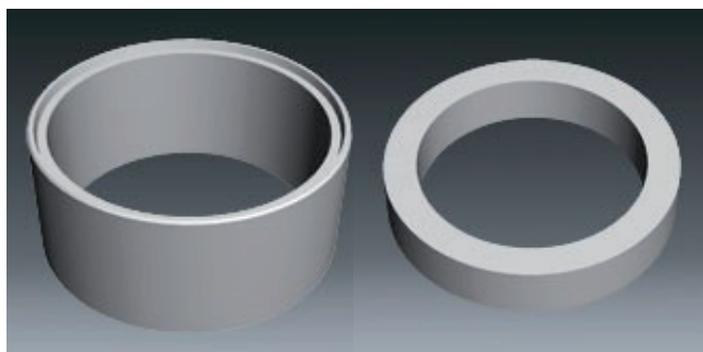

GU - Schächte



Straßenablaufschächte

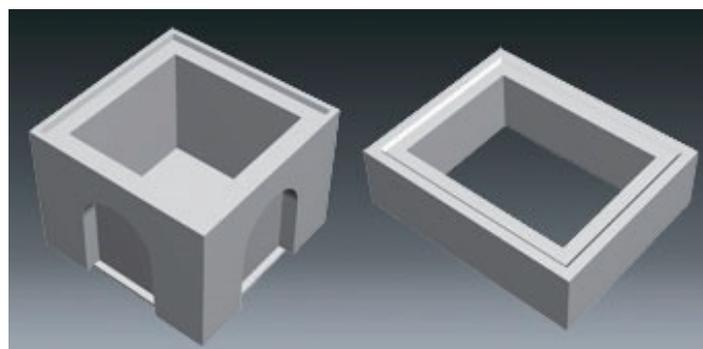

Wassertransportrohr System SN - 8

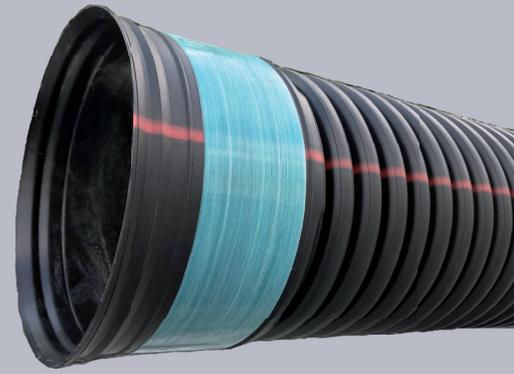

SN 4 - SN Kanal Rohprogramm  
inkl. Formteile, Rückstauklappen



KG2000 PP - SN 10 Programm  
inkl. Formteile



Schachtabdeckungen  
Späroguss und Grauguss



Einlaufgitter  
rund und eckig

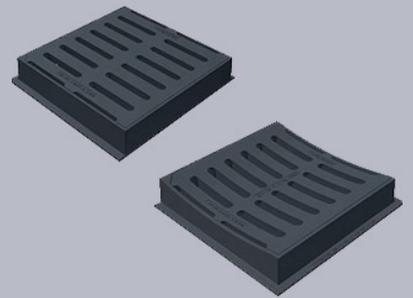

Vlies 110 - 290g/m<sup>2</sup>



PE Druckwasserrohre



PE Kanal Druckrohre (auf Bestellung)



Kabelschutzrohr in Rollen  
inkl. Zubehör



Kabelschutzrohr Stangen (auf Bestellung)



Tunnel - Drainage System  
inkl. Zubehör



Dränage System  
inkl. Drainageschacht



Dränage System  
inkl. Drainageschacht



XPS - Extruderschaum  
BG 30 glatt und rau



Granit Produkte



Betonleistensteine, Hochbordsteine,  
Gehwegplatten etc.



# Stonea

NATURSTEINIDEEN WIE SONST NIRGENDWO



1 STONEA Haftbrücke



2 STONEA Drainagemörtel

3 Drainagematte RM653

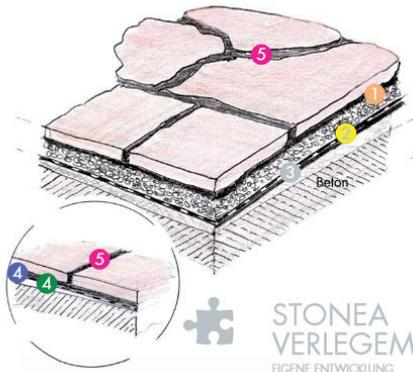
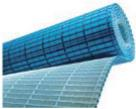

4 STONEA Natursteinkleber Flexkleber



5 STONEA Fugenmörtel

Offene Fuge DRAINAGEFUGE 1K



STONEA VERLEGEMATERIAL  
EIGENE ENTWICKLUNG

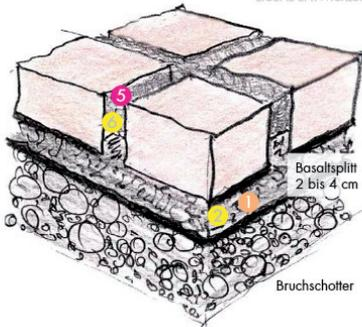

Basaltspalt 2 bis 4 cm

Bruchschotter

TRAVERTIN  
SAA KALKSTEIN  
SANDSTEIN  
QUARZIT  
LUSERNA  
BIASCA GNEIS  
PORPHYR  
GRANIT  
KLINKER  
FLIESEN  
FEINSTEINZEUG  
POOL  
MAUERN



Sackwaren: Zement  
 Mörtel  
 Trockenbeton  
 Stonea Verlegeprodukte



**KORMANN**  
**BAUSTOFFE**



# KORMANN

## BAUSTOFFE

# Kompetenz AM BAU

www.kormann.at



## Im Grazer Süden

Puntigamer Straße 140, 8055 Graz



»Dämmt besser. Denkt weiter.«

